



VETTERTEC SPRAY DRYING TECHNOLOGIES

Perfectly adapted to your individual requirements



ADVANCED TECHNOLOGY WITH A LONG TRADITION

Since 1930, VetterTec has been a specialist in designing, manufacturing and supplying industrial drying plants. Today, we are a one-stop supplier of industrial drying solutions, including dewatering and evaporation equipment – from R&D-scale and stand-alone equipment to fully integrated solutions. During the last decades, our equipment and systems have achieved a worldwide reputation for quality, reliability and return of investment.

Since 1984 we have been realizing spray drying projects all over the world, e.g. in the food, dairy and chemical industries. With locations in Germany, Great Britain, North America, Russia and China as well as representatives in 12 further countries, we implemented more than 180 spray dryer systems until today.

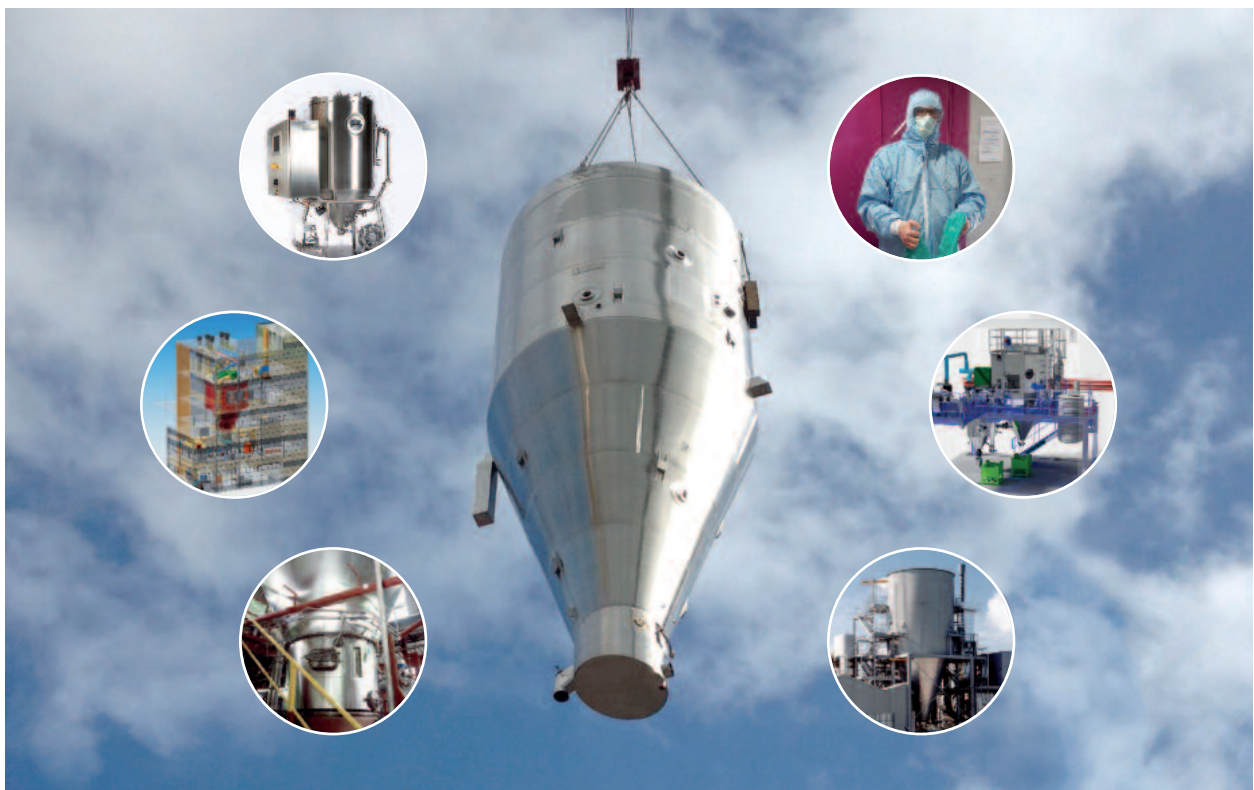

CUSTOMIZED SOLUTIONS – EXPECT MORE FROM VETTERTEC

Our experienced team of spray drying experts is always dedicated to developing the best solution for the specific needs of our customers, e.g. dust-free powder, agglomerated powder, etc.

With our deep know-how in particle engineering, our customers always get particles of the desired powder characteristics.

For tests and product developments, own test drying facilities are available – also for food-grade products, which meet highest hygienic standards.

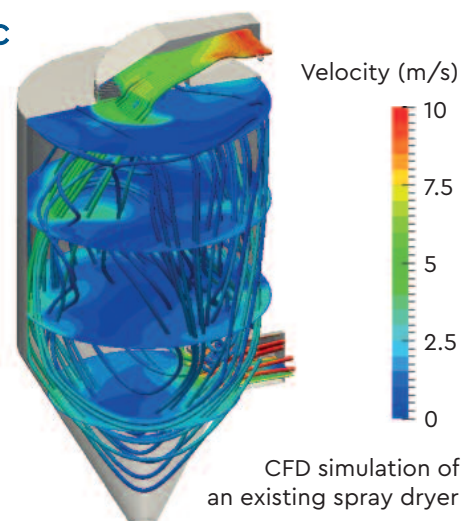

FROM PILOT PLANTS TO INDUSTRIAL UNITS

VetterTec provides a full range of spray drying systems and services.

- ✓ Complete supply of spray drying systems from reception bin to powder outlet
- ✓ Proven solutions adapted to customers' needs
- ✓ Precise engineering and manufacturing
- ✓ Project management from kick-off to commissioning
- ✓ Expertise in atomization and particle engineering

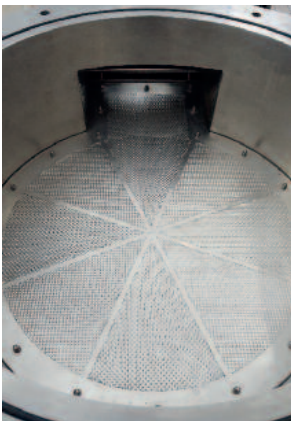
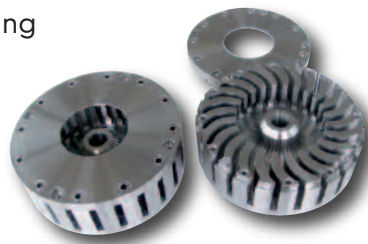

Internal fluid bed



External fluid bed

- ✓ Plant and process optimization
- ✓ Atomization systems (rotary and nozzle)
- ✓ Test centres for customer trials and application development
- ✓ CFD simulations
- ✓ Upgrades and retrofits
- ✓ Customer service, after sales
- ✓ Training and seminars

We manage your project from engineering until startup.



Pilot plant with homogenizer and safety equipment



Industrial plant in the chemical industry

ATOMIZATION SYSTEMS AND PARTICLE DESIGN

VetterTec supplies the complete range of atomization systems: rotary atomizers with a broad range of special wheels as well as high-pressure nozzles and twin-fluid nozzles. In addition to our own rotary dryer solutions, we also supply parts and complete atomizer retrofits for other brands.

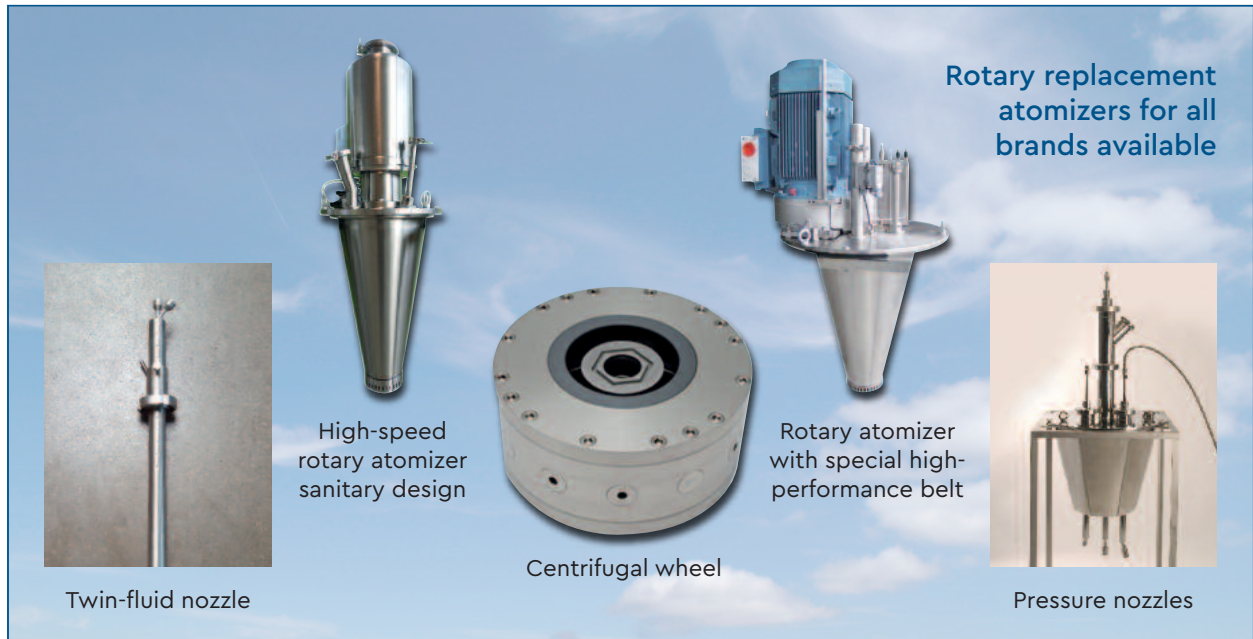

PARTICLE DESIGN AND DEVELOPMENT

- ✓ Dust-free powder
- ✓ Size and shape (form)
- ✓ Solubility
- ✓ Sinkability
- ✓ Particle size (distribution)
- ✓ Bulk density
- ✓ Agglomerated or non-agglomerated

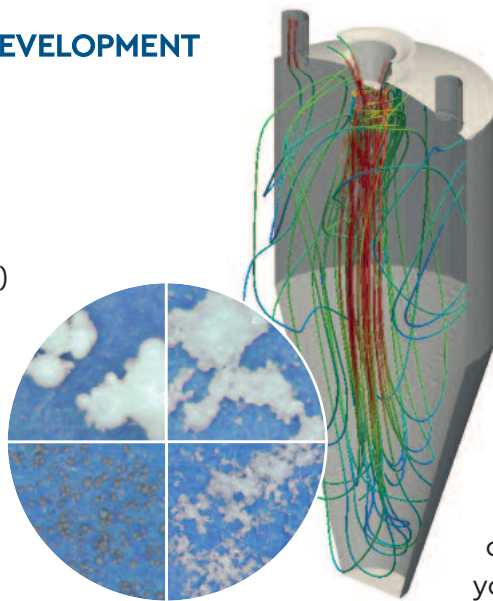

Deciding for VetterTec means opting for a reliable partner, whose drying experts ensure that your particles get exactly the right characteristics for your needs.



RELIABLE OPERATION FOR MANY APPLICATIONS

VetterTec spray dryers offer high flexibility of design. Direct or indirect heating systems are supplied depending on industry standards. Inlet temperatures may range from 100°C for very heat sensitive products up to 750°C for some inert chemicals. Closed circuit and self-inertized dryers are supplied to allow organic solvents to be removed while meeting all environmental requirements. Different chamber configurations are used allowing a range of residence times to provide the desired particle size and moisture content in the finished powder.

Agglomerated products, which are widely used in the food industries, are produced by using integrated fluid beds, fines recycle systems and external fluid beds.

VETTERTEC SPRAY DRYERS operate in the following applications:

Food Industry

- ✓ Whey
- ✓ Protein concentrates (fish, collagen, gelatin)
- ✓ Flavours
- ✓ Food dyes
- ✓ Soups
- ✓ Food supplements
- ✓ Glucose syrup
- ✓ Animal feed
- ✓ Enzymes



Starch and Brewery Industry

- ✓ Starch
- ✓ Maltodextrin
- ✓ Yeast
- ✓ Vegetable proteins (soya, sunflower seeds)
- ✓ Biochemical proteins



Chemical Industry

- ✓ Polymers (plastics)
- ✓ Acryl
- ✓ Carbonates
- ✓ Carbides
- ✓ Ceramics
- ✓ Pigments
- ✓ Metal powder
- ✓ Silica
- ✓ Dyestuff
- ✓ Herbicides



Do you miss your application? Feel free to contact us: We have several test facilities – also for food-grade products, which meet highest hygienic standards. Combined with our long-term experience we would be pleased to consult for the best drying result of your product.

We are your preferred partner for spray drying and product engineering.
Benefit from VetterTec's spray drying expertise and high flexibility of design.

SPRAY DRYER VETTERTEC CIRRUS NSD SERIES

SPRAY DRYING SYSTEM WITH NOZZLE ATOMIZER

The atomization is effected by a high-pressure nozzle or a twin-fluid nozzle in co-current laminar airflow, introduced via a special air distributor on the top of the drying chamber.

Evaporation rate: from 70 up to 11000 kg/h
Chamber diameter: from 2.5 up to 10 m

- ✓ Specially designed for non-agglomerated particles
- ✓ Large cylindrical chamber for bigger particles
- ✓ Main part of the powder is discharged at the chamber bottom
- ✓ Product can be further dried or cooled in an external fluid bed

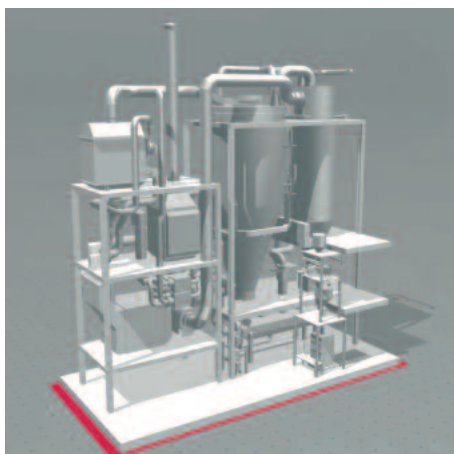

SPECIAL FEATURES

- ✓ External fluid bed
- ✓ Air brooms
- ✓ Side air outlet
- ✓ Fluid bed agglomeration
- ✓ Product cooling systems
- ✓ Integrated homogenizing
- ✓ Mirror-polished surface (optional)

SPRAY DRYER
CIRRUS NSD
for babyfood
ingredients

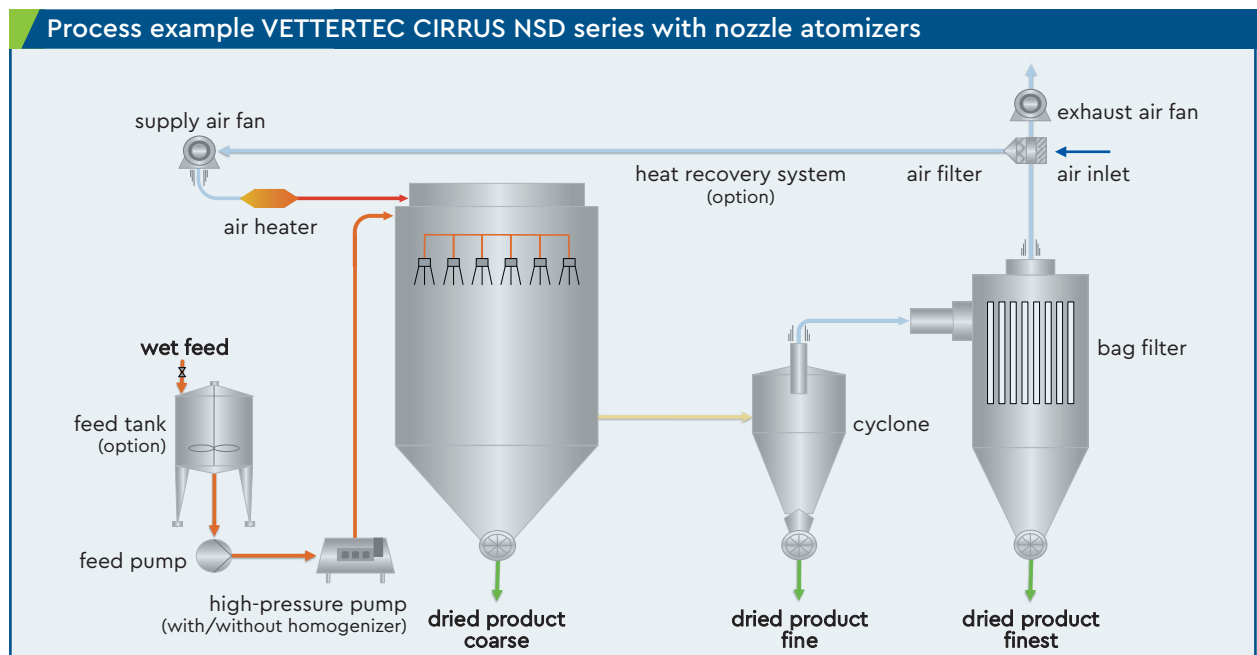

SPRAY DRYER VETTERTEC INCUS RSD SERIES

SPRAY DRYING SYSTEM WITH ROTARY ATOMIZER

The atomization is effected by a rotary atomizer (disc atomizer) in co-current airflow, introduced via a special air distributor on the top of the drying chamber.

Evaporation rate: from 60 up to 11000 kg/h
Chamber diameter: from 2.5 up to 13 m

- ✓ Specially designed for abrasive, highly concentrated and highly viscous particles
- ✓ Powder characteristics can be adapted by adapting different disc designs
- ✓ Product can be further dried or cooled in an external fluid bed

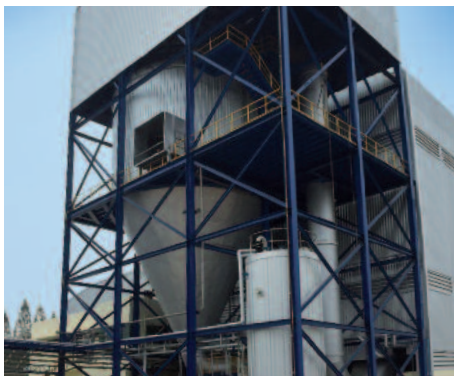

Spray dryer INCUS RSD in the starch industry for alcoholic yeast

SPECIAL FEATURES

- ✓ External fluid bed
- ✓ Air brooms
- ✓ Side air outlet
- ✓ Fluid bed agglomeration
- ✓ Product cooling systems

SPRAY DRYER INCUS RSD in the chemical industry for ceramic oxide/metal powder (inorganic pigments)

Process example VETTERTEC INCUS RSD series with rotary atomizer technology

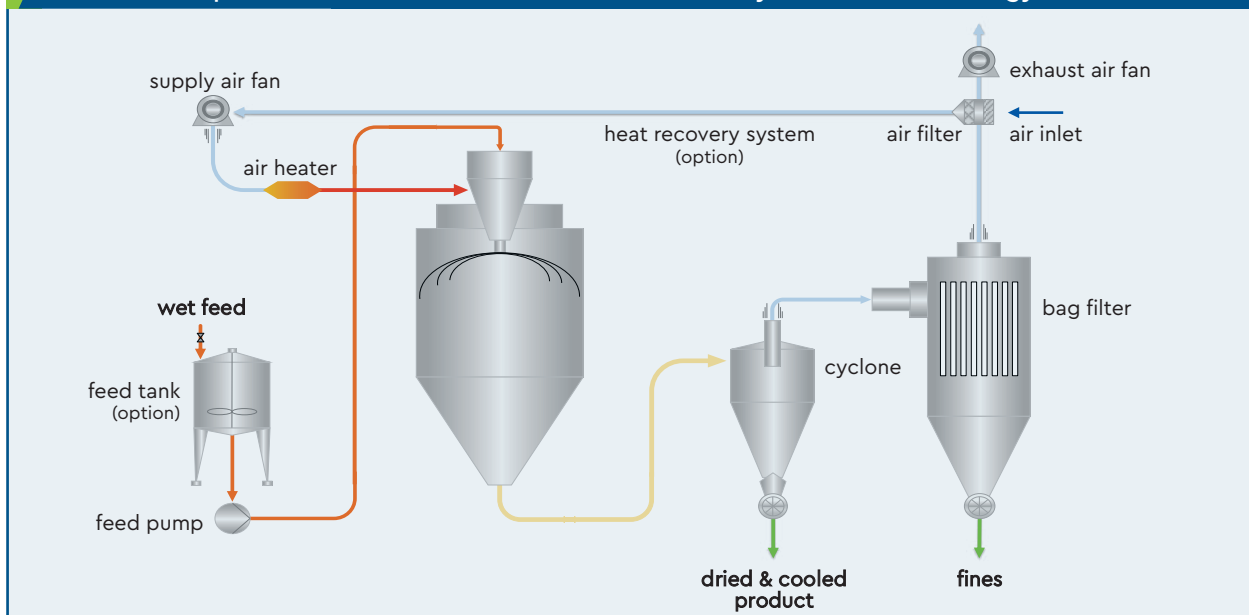

SPRAY DRYER VETTERTEC CUMULUS 3SSD SERIES

3-STEP SPRAY DRYING SYSTEM WITH INTERNAL AND EXTERNAL FLUID BEDS

The atomization is effected by a high-pressure nozzle atomizer in co-current airflow, introduced via a special air distributor on the top of the drying chamber. Internal and external fluid beds are added for fines removal and after drying. A versatile fines return system provides the necessary flexibility to control the degree of agglomeration by selecting the location of the fines injection back into the drying process.

Evaporation rate: from 70 up to 11000 kg/h
Chamber diameter: from 2.5 up to 13 m

- ✓ Specially designed for agglomerated free flowing, dust-free powder with high mechanical strength
- ✓ Mixed air flow
- ✓ With internal and external fluid bed for further drying, cooling and agglomeration



SPRAY DRYER CUMULUS 3SSD in the starch industry for malto-dextrin with external fluid bed



SPECIAL FEATURES

- ✓ Internal fluid bed
- ✓ External fluid bed
- ✓ Air brooms
- ✓ Top or side air outlet
- ✓ Fluid bed agglomeration
- ✓ Product cooling systems

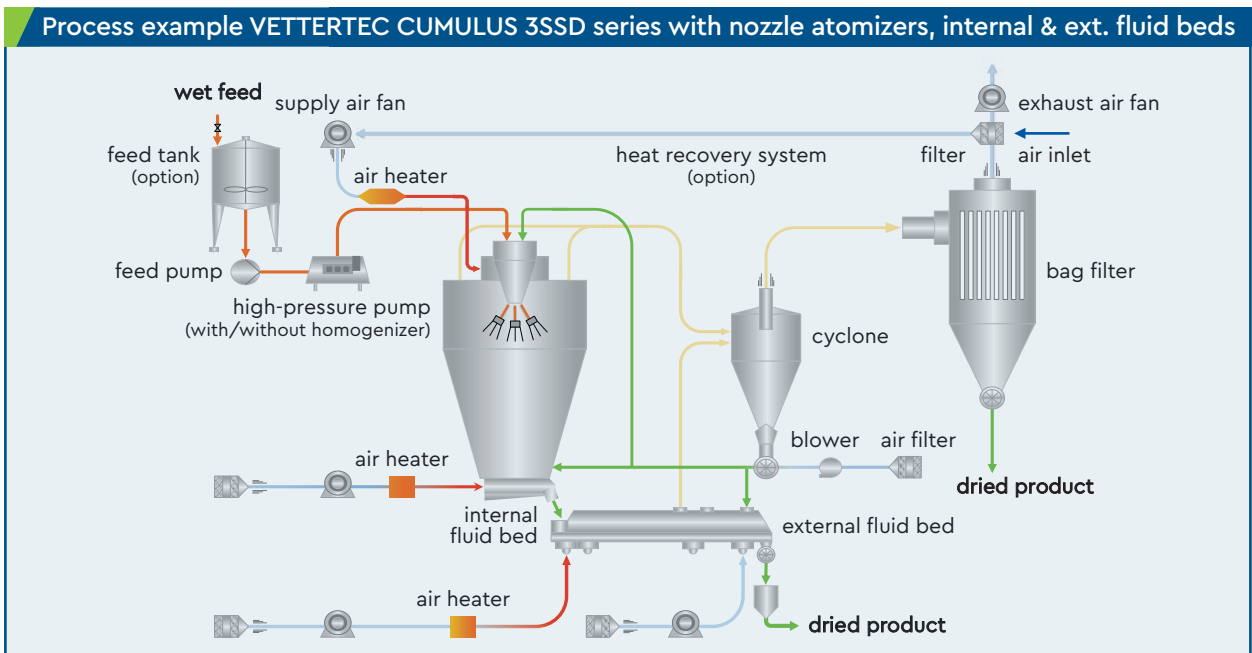

SPRAY DRYER VETTERTEC EXPERO SDL SERIES

LABORATORY SIZE SPRAY DRYING SYSTEMS

Our lab size dryer is designed to investigate multiple operation conditions, allowing reproducible powder production at laboratory scale.

The EXPERO SDL series is suitable for performing product testing prior to large scale production or for drying small powder quantities.

The atomization takes place via nozzle, twin-fluid nozzle or rotary (disc) technology or combined atomizers in co-current airflow, introduced via a special air distributor on the top of the drying chamber.

Evaporation rate: from 1 up to 70 kg/h
Chamber diameter: from 0.6 up to 2.5 m



© Fraunhofer

SPRAY DRYER EXPERO SDL-06 in a pilot plant for chemical products

ADAPTIVE DESIGN TO MEET CUSTOMER NEEDS

Same base frames, but different equipment, e.g. air distributor, internal fluid bed, filter, tri-clamp connections, bivalent air distributor, hoses, etc.

VETTERTEC EXPERO SDL series



ENGINEERING AND SUPPLY OF COMPLETE SYSTEMS

VetterTec is a one-stop supplier of dewatering and industrial drying solutions, from R&D-scale and stand-alone equipment to fully integrated production lines and continuous manufacturing systems – for sophisticated liquid, powder and bulk solid production processes in the starch, food, chemical, bioethanol/alcohol, brewery and many other industries.

VetterTec is able to act as strategic development partner and system or equipment supplier depending on customers' needs.

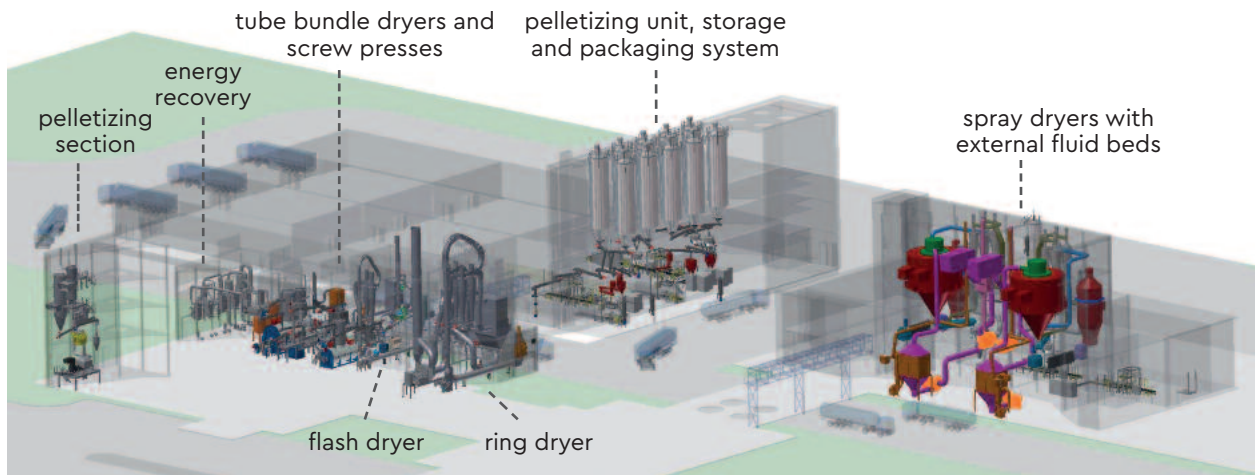

Engineering example: corn starch production plant

VetterTec's systems and equipment are renowned for their robust design, engineering, process quality and efficiency. Ranging from fluid bed dryers, flash and ring dryers, industrial spray dryers, through to tube bundle dryers, evaporators, presses and brewery conveyors and storage equipment, customers have a **wide range of flexible and fully customizable solutions** to choose from.

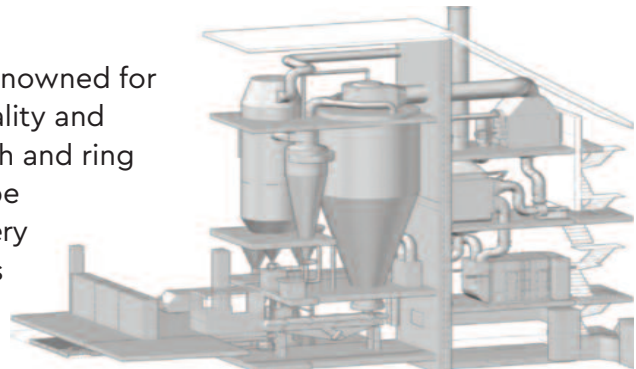

Our experienced process engineers will assist you in optimizing your performance, timely and efficiently. Our clients count on our service organization to optimize their ROI using VetterTec's customized solutions. Over 3500 reliably operating drying solutions and systems supplied worldwide, confirming our slogan **SUCCESSFUL DRYING SYSTEMS.**



CONTACT US!

Our drying experts will always find the best solution that suits your specific needs.

WE CARE!

SAFETY SYSTEMS



Spray dryers in general have high safety requirements. VetterTec experts work hand in hand with safety component experts and have the proven specific know-how to implement the required system in accordance with all relevant safety requirements. All our dryers fit the latest safety standards. **If you already have a dryer, do not hesitate to contact us: We offer suitable safety retrofit solutions.**

We also supply closed cycle systems for highly explosion-sensitive products.



SUSTAINABILITY OF PERFORMANCE

Our commitment doesn't stop after successful startup. VetterTec offer to continue the close relationship with our customers to ensure an optimized life cycle for operation/ maintenance cost and performance – **always ensuring the best powder results.**

- ✓ Installation and commissioning
- ✓ Genuine spare parts and components
- ✓ Repair service and refurbishment
- ✓ Consultation for process optimization and plant expansion
- ✓ Preventative maintenance and inspections
- ✓ Plant modernization/upgrades and modification of equipment
- ✓ Retrofits and replacements
- ✓ After sales service
- ✓ Tailored trainings (maintenance and operation)

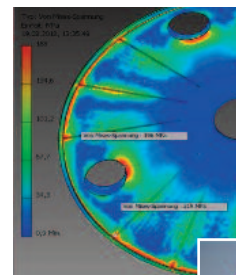

Analysis and upgrade:
Engineers at VetterTec are...

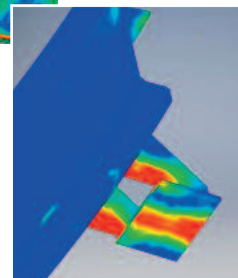

... experts in process optimization

But even if you don't have a VetterTec dryer (yet), we are pleased to offer our services and optimize your dryer!



VETTERTEC WORLDWIDE

CONTACT US AND FIND OUT
how we can help you achieve more!



vettertec.com

Head office (Germany)
VetterTec GmbH
Tel. +49 561 50019-0
info@vettertec.com

Germany
VetterTec GmbH
Tel. +49 7121 9017-0
werco@vettertec.com

North America
VetterTec Inc
Tel. +1 450 505 6111
info.na@vettertec.com

United Kingdom
VetterTec Ltd
Tel. +44 1732 441440
info.uk@vettertec.com

P.R. China
VetterTec China Co. Ltd.
Tel. +86 13 901800861
info.cn@vettertec.com

